

XCM022R2-SCH-F.pdf

HUMANDATA
 HUMANDATA LTD.
 www.hdl.co.jp (Japan)
 www2.hdl.co.jp/en/ (Global)

TITLE	KINTEX FBG484 FPGA Board	
DOC. No.	XCM-022Z	
FILE: XCM022F.sch	DATE: 2024/07/16 10:04:52	Sheet: 1 / 4

- V31A V31A
- V30B V30B
- VCCINT_10 VCCINT_10
- VMG1VCC_10 VMGTAVCC_10
- VMG1VCC_12 VMGTAVCC_12
- VMG1AVCC_AX_18 VMGTAVCC_AX_18
- VCC_AUX_18 VCC_AUX_18
- VCC_ADR_18 VCC_ADR_18
- VCC_CA VCC_CA
- VCC_CB VCC_CB
- VCCOE VCCOE
- GND GND

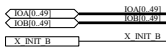

BANK Group B

BANK Group A

FGPAB

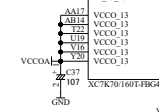
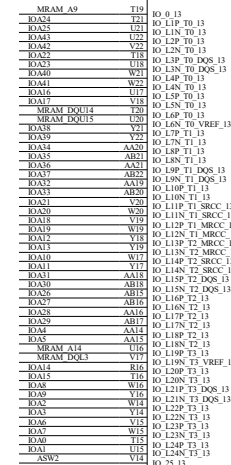

FGPAC

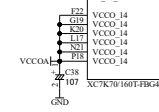
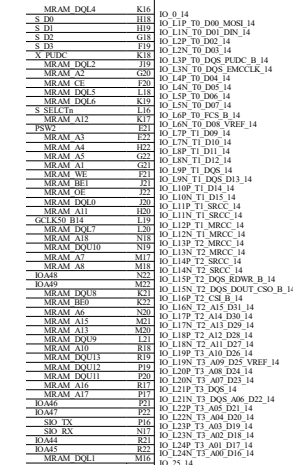

FGPAE

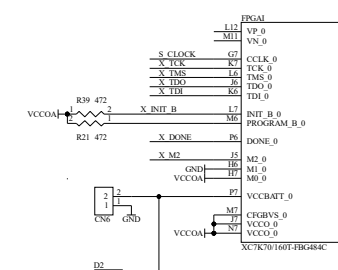
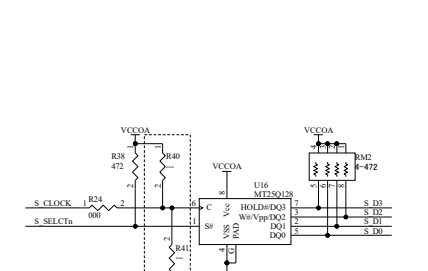
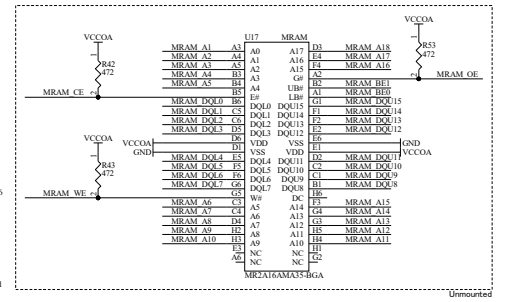
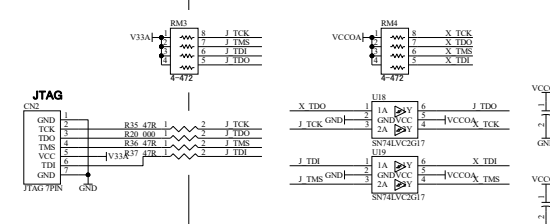
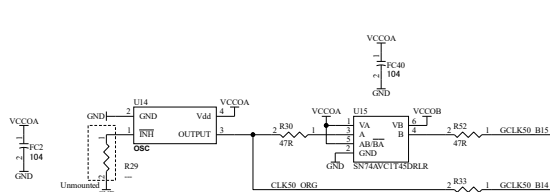
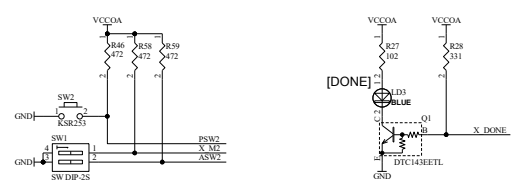
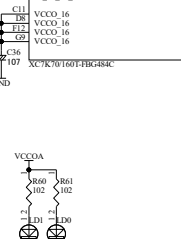
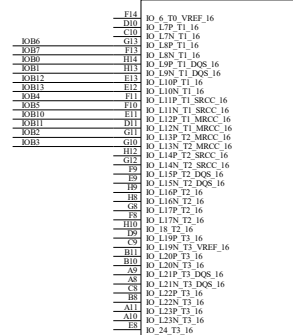

HUMAN DATA
HUMAN DATA LTD.
www.hd.com.sg (Singapore)
www2.hdi.co.jp/en / (Global)

DATE: 2024/07/16 10:04:52 Sheet: 2 / 4

Doc. No: XCM-022Z **F**

FILE: XCM022_ZIO.sch DATE: 2024/07/16 10:04:52 Sheet: 2 / 4
V3.020021

XCM022Z2-SCH-F.pdf

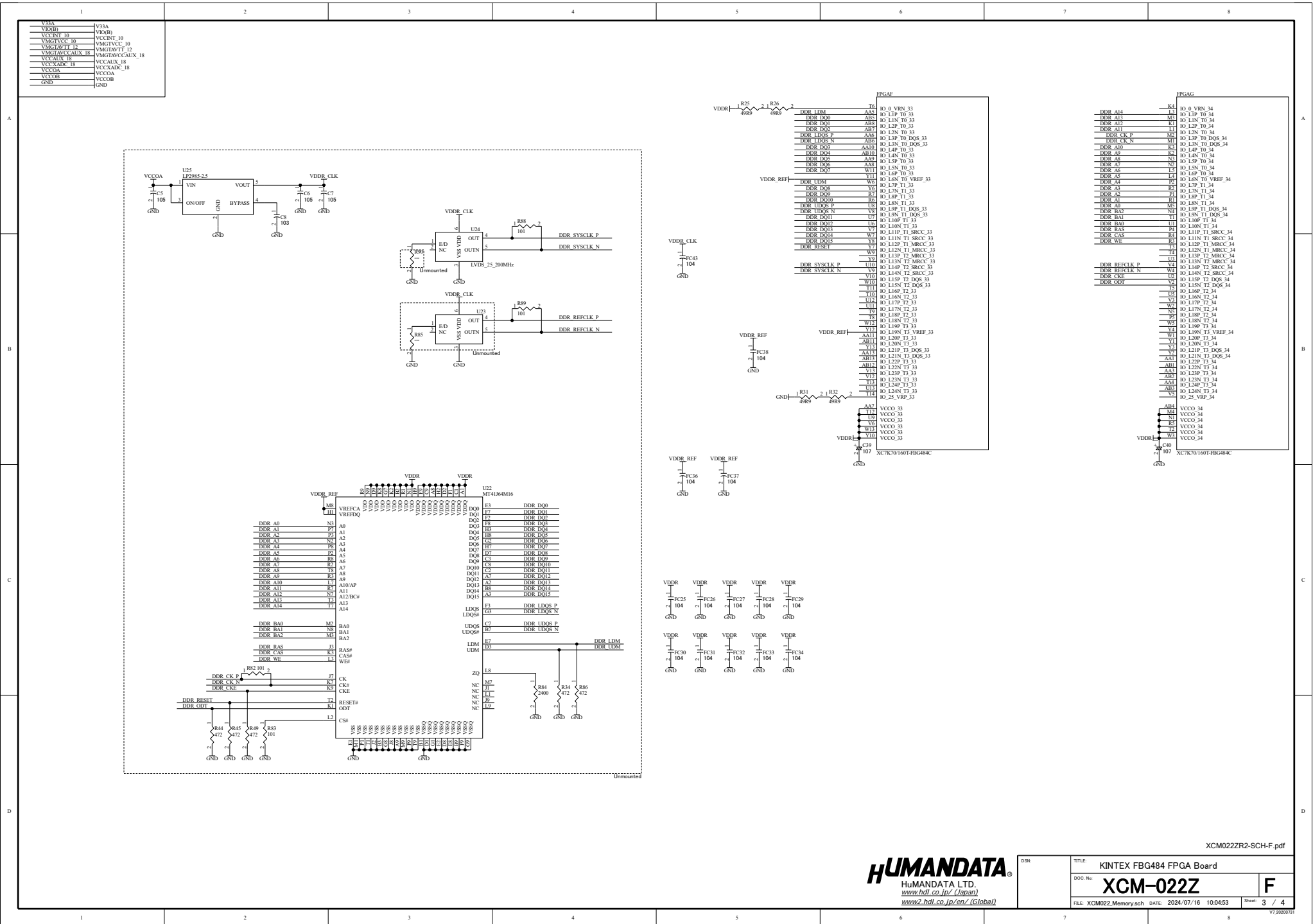

V33A	V33A
V60B1	V60B1
VCCINT_10	VCCINT_10
VMGTAVCC_10	VMGTAVCC_10
VMGTAVTT_12	VMGTAVTT_12
VMGTAVTT_12	VMGTAVTT_12
VMGTAVCC_AUX_18	VMGTAVCC_AUX_18
VCC_AUX_18	VCC_AUX_18
VCC_AUX_18	VCC_AUX_18
VCC_AUX_18	VCC_AUX_18
VCC_AUX_18	VCC_AUX_18
VCCOAV	VCCOAV
VCCOAV	VCCOAV
VCCOAV	VCCOAV
VCCOAV	VCCOAV
VCCOAV	VCCOAV
VCCOAV	VCCOAV
GND	GND

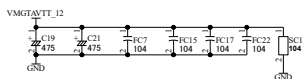
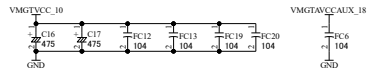
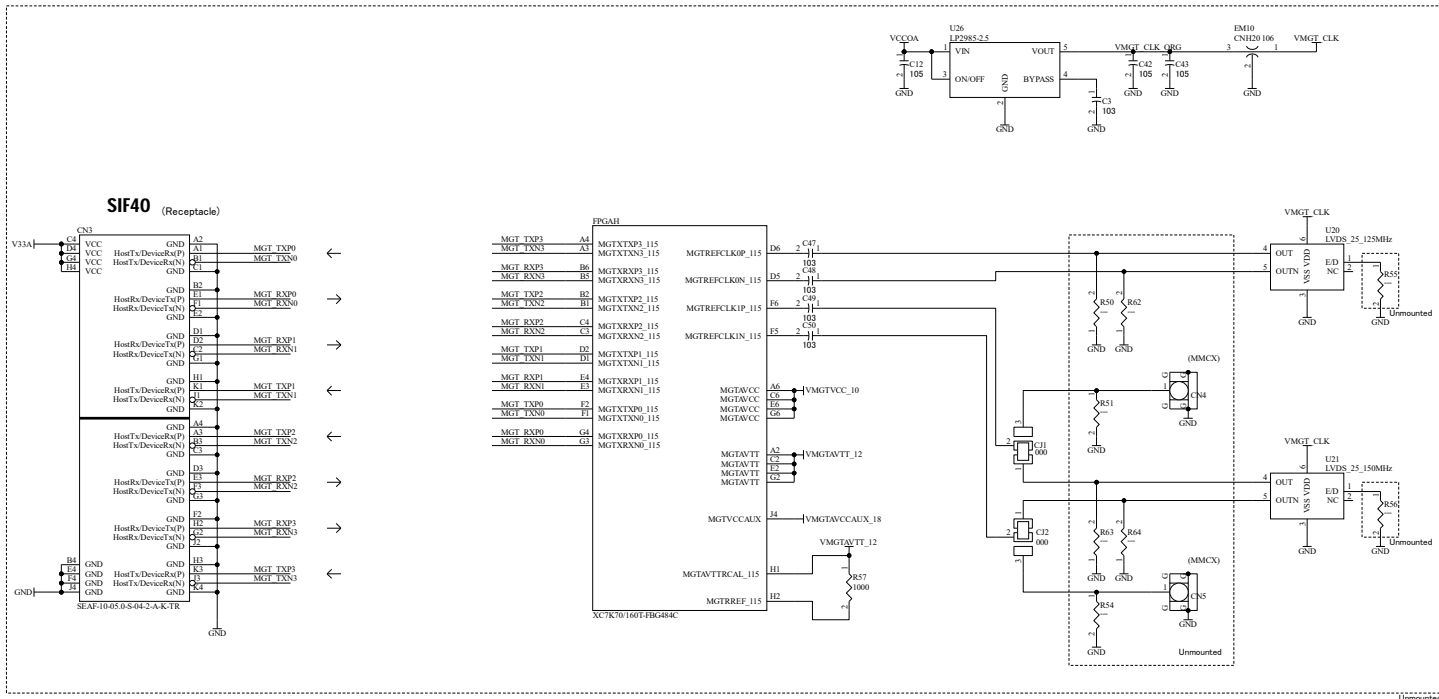

XCM022R2-SCH-F.pdf